



UNIA

ARES
DISC HARROW



uniamachines.com



UNIA Sp. z o.o. is a Polish manufacturer offering the largest complex range of agricultural products in Europe.

We own 4 modern factories, equipped with world-class production equipment. Our history and knowledge dates back to almost 140 years. First cultivator and reversible plough in the world were produced in our factory.

Our products, through specialized distributors, reach farmers in more than 60 countries of the world, on every continent.

Thanks to this knowledge, we offer our customers not only modern machines, but also the best agronomic solutions used in the world's most demanding markets.

We offer a complex range of agricultural equipment: ploughs and cultivators, seeding equipment and combination seed drills, spreaders, balers and bale wrappers, sprayers, potato harvesters as well as grain storage technology.

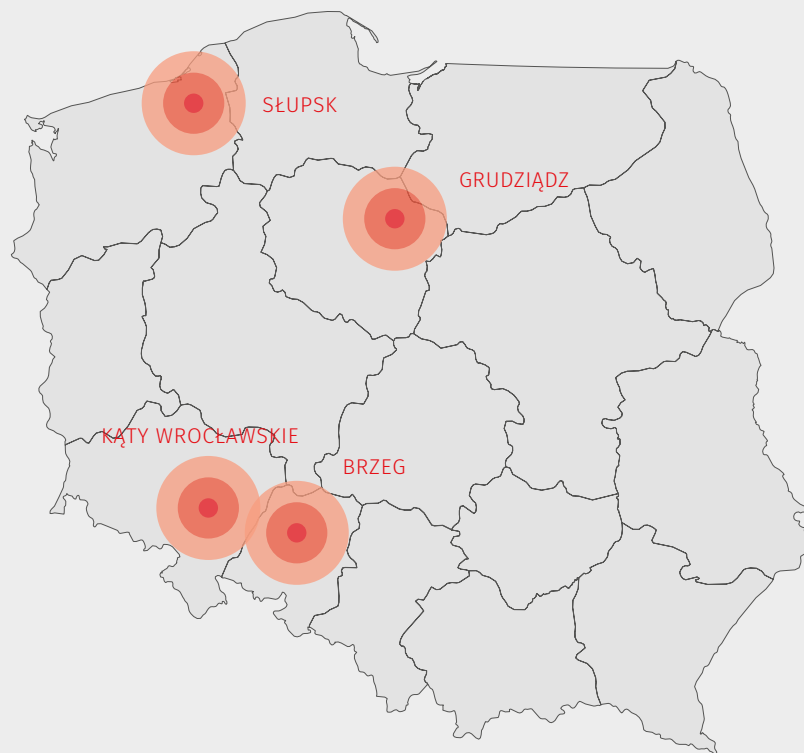

4

FACTORIES

11,5 ha

PRODUCTION
AREA

1200

EMPLOYEES

700

ITEMS
IN OFFER

60

MARKETS

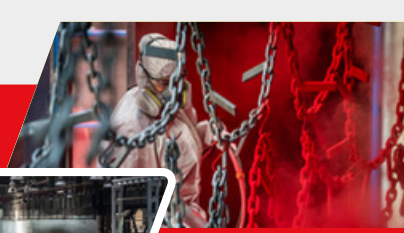
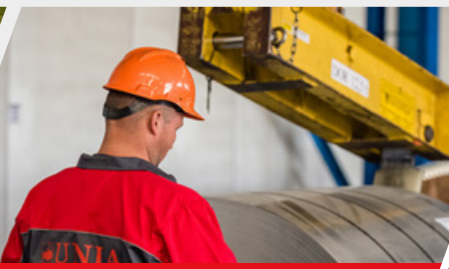

OVER 70 YEARS OF EXPERIENCE

IN THE DISC HARROWS

MANUFACTURING

The design of the first Polish disc harrow adapted to aggregation with a tractor was developed by the designers of Fabryka Narzędzi Rolniczych in Grudziądz in 1949. The model was marked as ŁBD-4.5 and had a working width of 4.5 m.

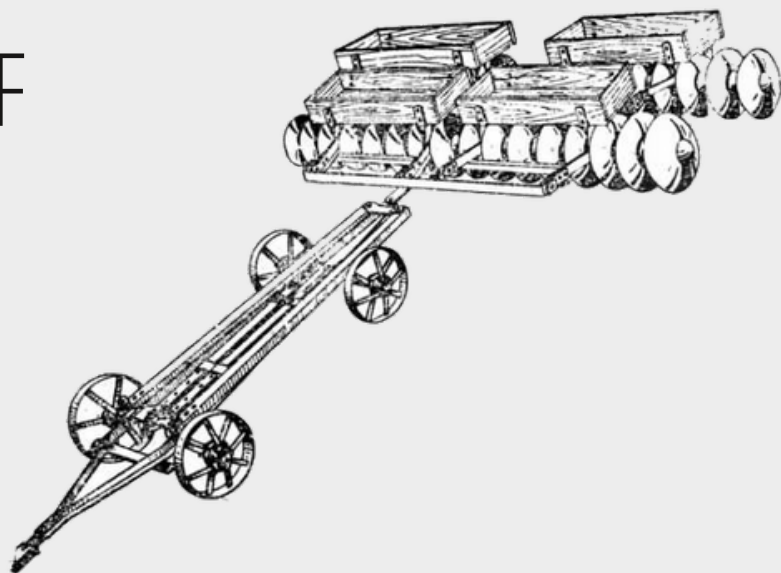



Innovative ARES

The year 2002 was the time when the ARES parallel disc harrows were introduced to production. UNIA was the first manufacturer in this part of Europe that started the production of a multi-purpose aggregate. The machine has introduced a new standard for stubble cultivation. It gained additional recognition thanks to the innovative concept of connection with a seeder, farmers were given the opportunity to create cultivating and sowing units for the first time.



PERFECTLY DESIGNED CONSTRUCTION

The ARES series consists of six models of compact disc harrows adapted to work on any farm.

The smallest one has 2.5 meters and the largest 12 meters of working width. Proven design and the possibility of configuration of working elements meet the farmers' requirements.





PERFECTLY DESIGNED WORKING ELEMENTS

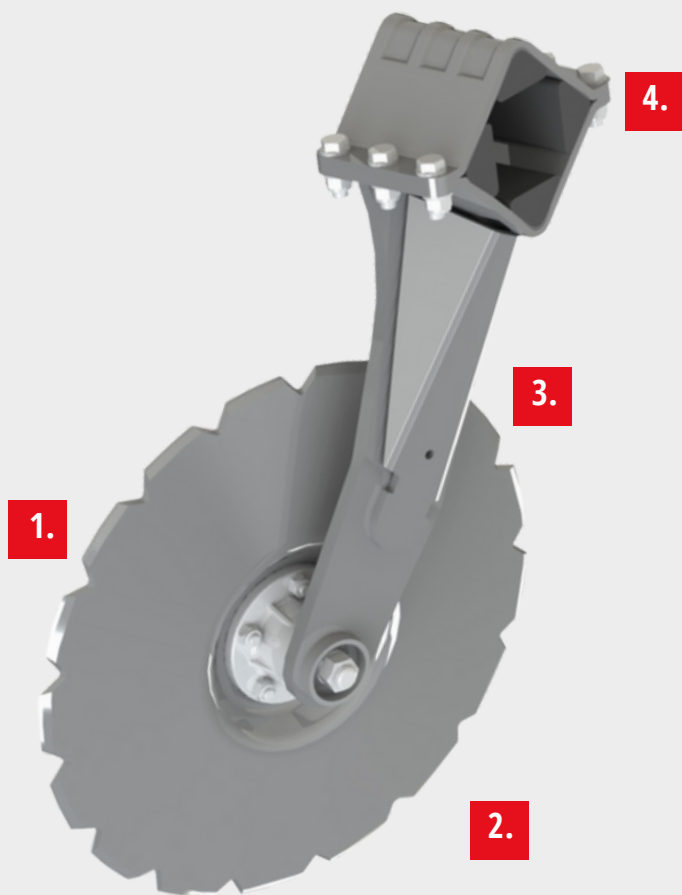

1. UNION DISC CUTTERS

Made of high-quality Swedish SSAB boron steel. The unique manufacturing process guarantees high durability, each plate is individually hardened. The cutters are evenly hardened and have exactly the same shape. All this translates into high durability in field conditions.

2. MAINTENANCE-FREE HUBS

They combine high strength, necessary for working in the field, and a compact design that does not obstruct the soil flow. They are attached to the plough standard with one screw. Lock openings ensure a permanent connection and facilitate service work. The hub nut is protected by a ring.

3. DISC FIXING SYSTEM



One plough standard holds one disc, which facilitates penetration of the cutters in the soil, maintaining the working depth and following the terrain. The profile of the plough standard corresponds to the shape of the disc and is made of HARDOX steel.

4. RUBBER SHOCK ABSORBERS

The triangular shape maintains a larger contact area with the beam and the disc mounting assembly. The cutters retain the same depth and the vibrating working elements do not transmit vibrations to the machine. The used mixture is of high quality and retains its parameters regardless of the temperature at which the work is performed.

DISC CUTTERS

Depending on the selected model of the ARES disc harrow, disc cutters are available in three different diameters: 510, 560 and 660 millimetres.

CLASSIC discs with small cut-outs around the perimeter are perfect for shallow stubble cultivation and for preparing the field for sowing. Small notches allow for intensive cultivation with shallow working depth..

AGRESSIVE discs are adapted to work with more harvest residues, on heavier soils. The elliptical shape and deep notches with sharpened edges allow to cut

and mix large amounts of stubble residues and catch crops.

CLASSIC



AGRESSIVE



TX PROTECTION

Heavy disc harrows such as ARES ROLLER UP, P and HP can be equipped with spring protection for each of the discs.

This allows to work on heavily stony fields. The discs used in the TX system have a diameter of 660 mm, which allows them to work in conditions with a large amount of stubble residues.

The TX protection is available on the ARES ROLLER UP, ARES P and ARES HP disc harrows.

- 1. AGGRESSIVE APPROACH ANGLE**
- 2. THE SHAPE OF A PLOUGH STANDARD IN THE SHAPE OF A DISC CUTTER**
- 3. PLOUGH STANDARDS FITTED ON HARDENED SLIDE BUSHES**
- 4. PRE-CHARGED SPRING WITH LIMITER**

ADVANTAGES OF THE TX SYSTEM

- The working depth is maintained even on harder ground.
- The disc release force is 450 kg
- The discs are always guided with great accuracy.
- Optimum pressure on the individual discs, precise adherence to the working position and constant triggering force.
- Maintenance-free replaceable bearings

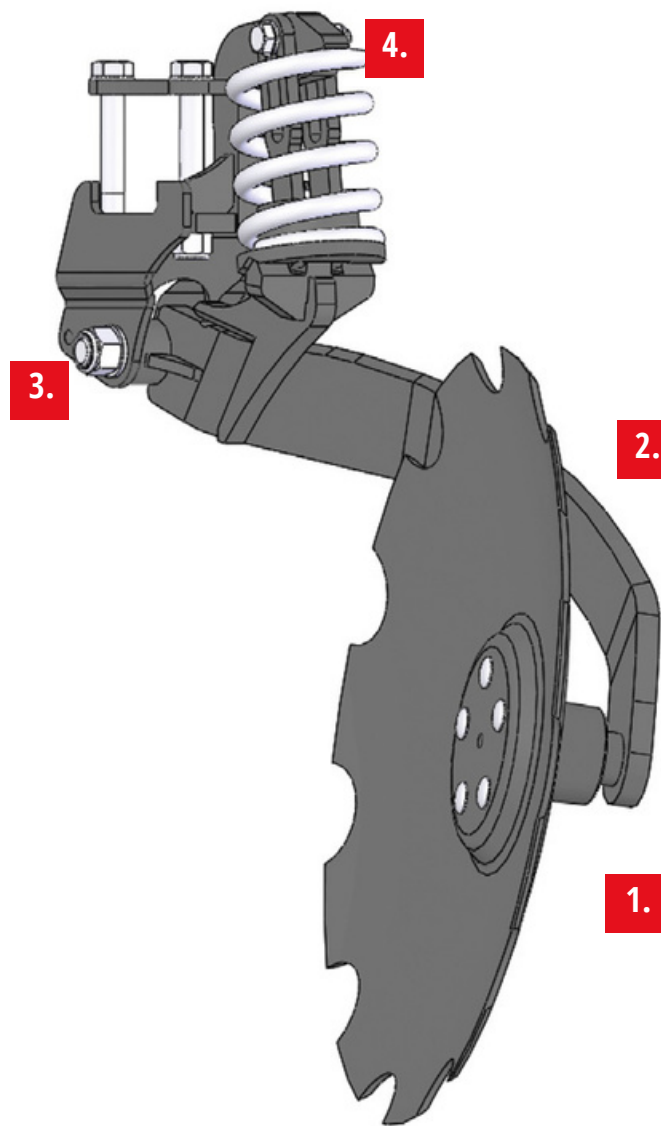





EFFECTIVE LAYOUT OF WORKING ELEMENTS

Unique approach angle of disc cutters.

The unique approach angle of the discs ensures full undercutting during stubble cultivation and intensive mixing of harvest residues with the soil.

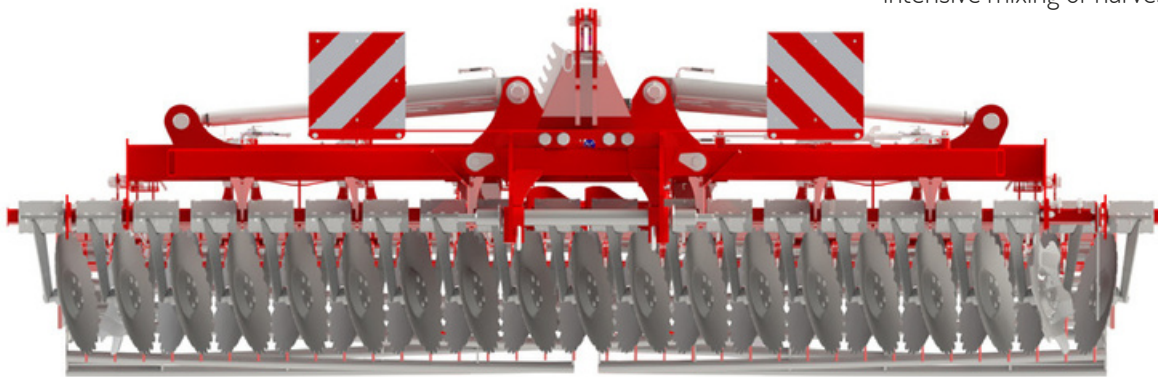

The arched shape of the frame allows for high ground clearance, which directly translates into the flow of cultivated soil and crop residues.

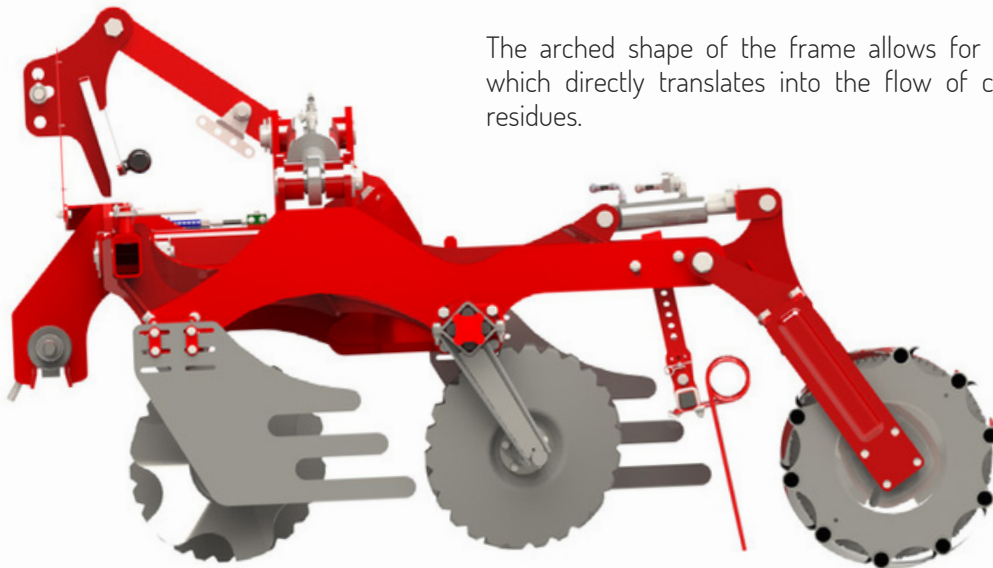



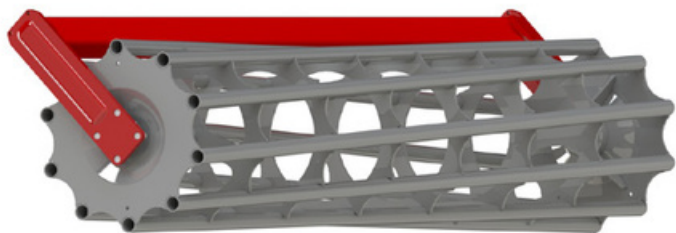

TUBE ROLLER

- It compacts light and medium soils best, while its low weight does not guarantee adequate compaction of heavy soils.
- It consolidates the top layer to a small depth.
- Its biggest advantage is the large contact surface with the soil, thanks to which the machine does not sink excessively and maintains the desired depth on light soils.

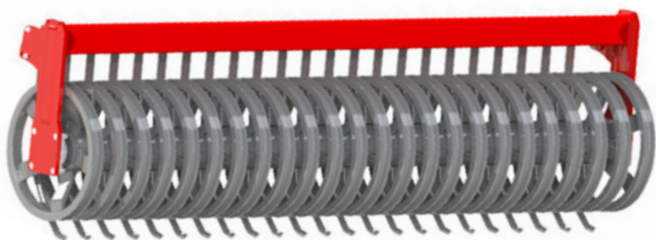

U- PROFILE ROLLER

- The U-profile rings fill with soil when working on clay soil, which prevents the formation of a crust on the field surface.
- On sandy ground, the large support surface of the U-profile allows to maintain the set working depth of the machine.
- The roller consolidates the soil in strips to an average depth.
- It is equipped with cleaning strips as standard.

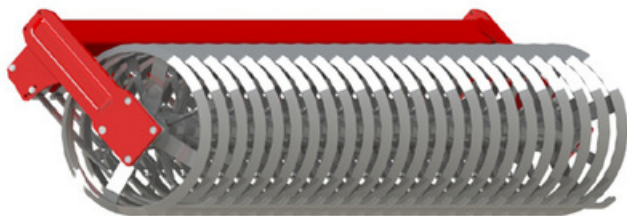

V-RING ROLLER (SPIRAL)

- The v-ring roller works best on heavy and compact soils.
- The structure made of V-shaped rings is great for crumbling of the clods of soil.
- The roller acts in stripes on the deeper layers of soil.
- Standard equipped with anti-clogging strips.

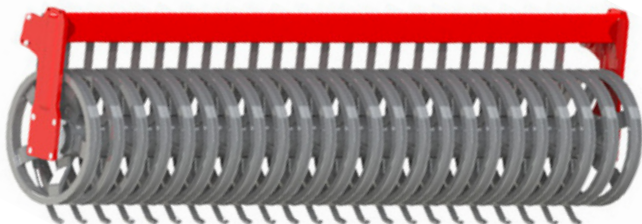

T- PROFILE ROLLER

- It has good crushing properties and maintains the lumpy structure of the soil.
- It makes the decomposition of crop residues easier.
- It compacts the soil deeply.
- Standard equipped with anti-clogging strips.

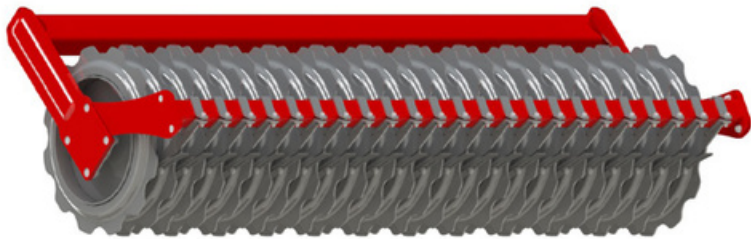

TIN ROLLER

- This is a heavy roller that provides strip consolidation.
- It improves the conditions of water and gas exchange in the soil.
- It crumbles and accelerates the decomposition of organic matter.
- Standard equipped with adjustable scrapers that can be turned inside out

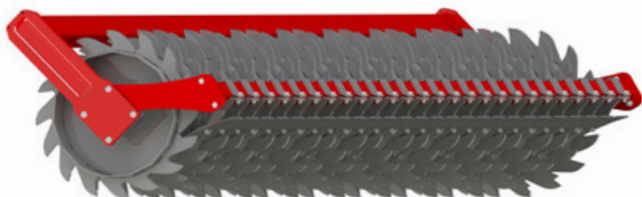

PACKER ROLLER

- The large support surface allows for work on lighter soils. It has good crushing properties.
- It creates an excellent seedbed.
- Equipped with adjustable scrapers.

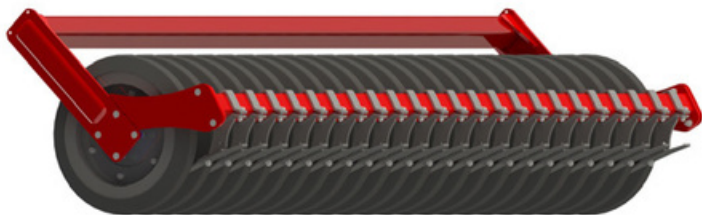

RUBBER ROLLER

- Consolidates the soil in strips, causing good soil soaking where the rubber rings work.
- It works perfectly in combination with a seeder, the seeds that hit the pit germinate quickly.
- Suitable for all types of soil.
- It is equipped with a set of scrapers as standard.



SYSTEM DRIVE

- The roller compacts the soil in strips corresponding to the width of the tires.
- Due to the use of tires with agricultural tread, there is no problem of clogging, so it can be successfully used on all types of soil.
- The wheels are mounted in pairs, which greatly facilitates any repairs.

FRONT MOUNTED ATTACHMENTS

Additional options for semi-trailed harrows

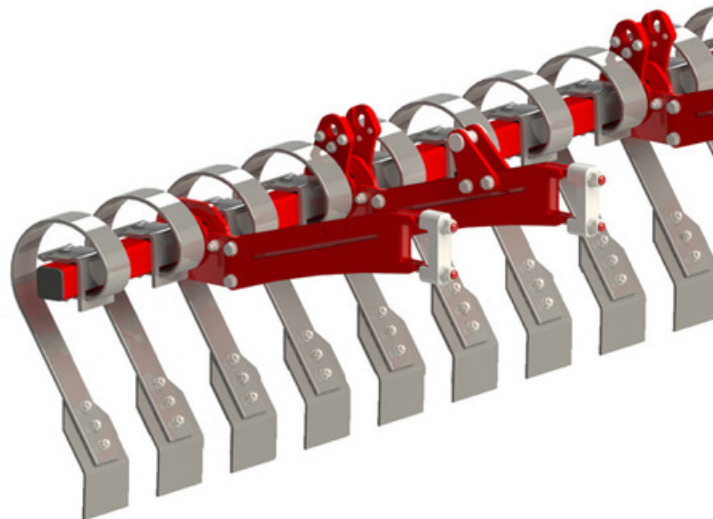

SUPPORT WHEELS

They are optional accessories for all semi-trailed ARES harrows. The wheels maintain the working depth, provide better ground following and stabilize the machine during operation.

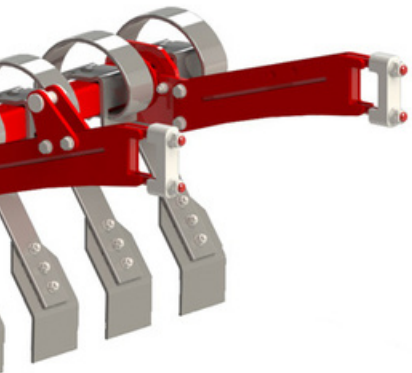

HYDRAULICALLY CONTROLLED LEVELING BAR

It works great in pre-sowing cultivation. The 150 mm wide plates mounted on springs crush larger clods of soil. The working depth is adjusted from the tractor cabin with the use of hydraulic cylinders.

The dragline can be fitted to the ARES L (semi-mounted and DRIVE versions),

ARES

XL and ARES XM models.



ARES XL
ARES XL
A



ARES XL
ARES XL
A



ARES
XM
ARES HP

FP SEED DRILL

UNIA disc harrows (except ARES ROLLER UP) can be equipped with a FP precision seeder for catch crops, during cultivation, plants with small and coarse seeds can be sown. UNIA FP allows to reduce the number of passes on the field.

FP seed drills work in the range of 5 - 350 kilograms per hectare.



▲
FP 250

FP 550





ARES L

This is the most compact disc harrow in UNIA's offer. Available in four widths with a rigid frame; 2.5, 3, 3.5 and 4 meters. Depending on the selected specification, the machine can be mounted on the tractor's three-point linkage arms, a semi-trailed one transported on a tire packer or a semi-trailed one with a chassis.

The short and solid frame has been the hallmark of the ARES L disc harrows for many years, the appropriate weight of the machine allows to work with tractors with a power of 70 HP. 510/4 mm discs allow for effective stubble cultivation. The possibility of retrofitting a hydraulic coupler to the seeder allows the creation of cultivating and seeding units for smaller tractors.





Far cutter
Foldable and adjustable

RAEX 500 sheet,
16 mm thick

The frame is based on a
100x200 mm profile



Suspension axle compatible
with UNIA machines

CLASSIC or AGRESSIVE discs

ARES L

Spot adjustment
of the working depth



Cutter of a smaller diameter
with deep notches

TECHNICAL DATA



70 - 130 kW
power demand

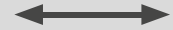

2,5 - 4 m
working width

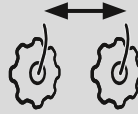

64 cm
spacing between rows
of discs

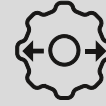

ø 560 / 4 mm
disc diameter - XL

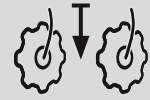

MAX 15 cm
max. working depth

ARES L	2,5	3	3,5	4
Weight with pipe roller [kg]	920	1080	1300	1420
Power demand [HP]	75-90	80-100	100-120	110-130
No. of discs [pc.]	20	24	28	32
Spacing between rows of discs [cm]	64	64	64	64

wheel scrapers

It is possible to retrofit a hydraulic coupler to the seeder

RAEX 500 sheet, 16 mm thick

The frame is based on a 100x200 mm profile



High-pressure tires with a diameter of 670mm

CLASSIC or AGRESSIVE discs

Two lifting cylinders with a pawl system

ARES L DRIVE

MACHINE

IN HOMOLOGATED VERSION



Drawbar leveling spindle



The possibility of retrofitting
with the front hydraulic dragline

Semi-trailing axle
with variable category III/2 or III

TECHNICAL DATA



80 - 136 M
power demand



3 - 4 m
working width

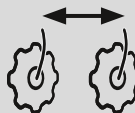

64 cm
spacing between rows
of discs

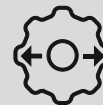

ø 510 / 4 mm
disc diameter - XL



MAX 13 cm
max. working depth

ARES L DRIVE	3	3,5	4
Weight with pipe roller [kg]	1530	1740	1930
Power demand [HP]	80-100	100-120	110-130
No. of discs [pc.]	24	28	32
Spacing between rows of discs [cm]	64	64	64

ARES L PLUS

It is a disc harrow that will work both during deeper stubble cultivation and in combination with a seeder. The compact design does not overload the tractor's three-point system.

Discs with a diameter of 560/4 mm allow to work at a depth of 15 centimetres. The distance of the cutters ensures intensive mixing of the cultivated soil.





ARES L PLUS

UNIA



The frame is based on a 100x200mm profile

RAEX 500 sheet, 16 mm thick

Far cutter
Foldable and adjustable

Two heights of attaching the three-point linkage arms

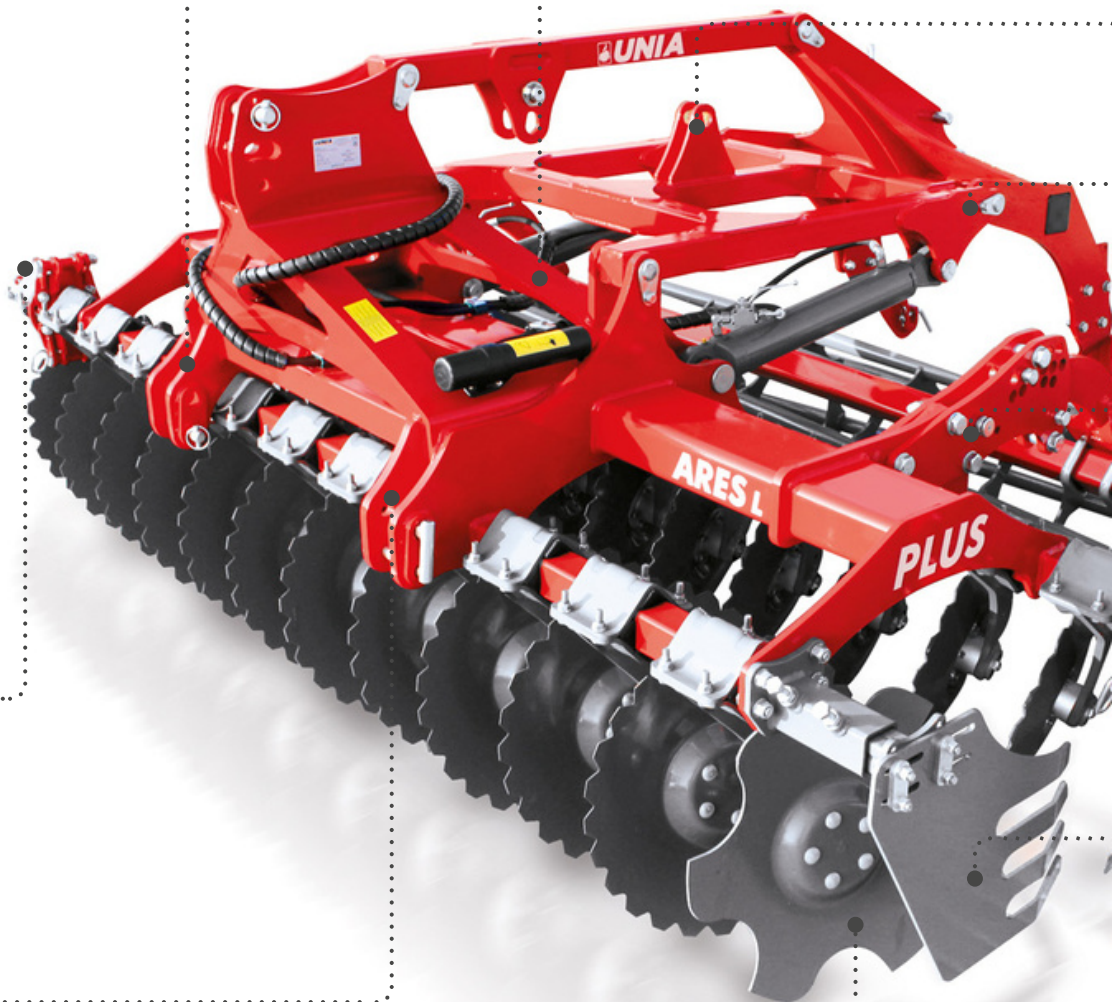

ARES L PLUS

Transport protection

Coupling to the seeder
Raised by two cylinders

Spot adjustment of the
working depth

Adjustable deflector

Cutter of a smaller diameter
with deep notches

TECHNICAL DATA



75 - 160 ¹⁶⁰ kW
power demand



2,5 / 3 / 4 m
working width

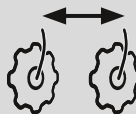

70 cm
spacing between rows
of discs

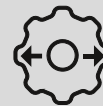

ø 560 / 4 mm
disc diameter - XL



MAX 13 cm
max. working depth

ARES L PLUS	2,5	3	4
Weight with pipe roller [kg]	1100	1240	1610
Power demand [HP]	75-110	80-130	110-160
No. of discs [pc.]	20	24	32
Spacing between rows of discs [cm]	70	70	70

